

Assembly Instructions

SPENCER

DINING CHAIR-F299



ver 1.1

loungelovers

WARNING

FAILURE TO FOLLOW THESE BASIC STEPS CAN LEAD TO DAMAGE THAT IS NOT COVERED BY YOUR WARRANTY

1



Read Instructions carefully. Check no parts are missing.

2

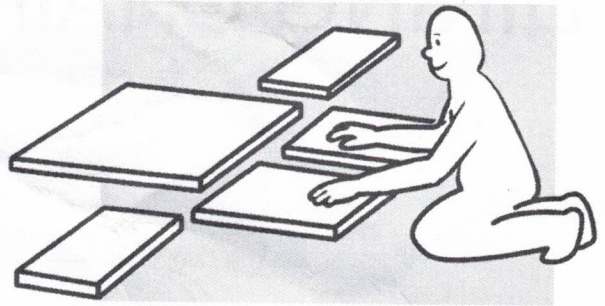

Lay out all of the components on a soft surface as if you were preparing to do a jigsaw puzzle.

3

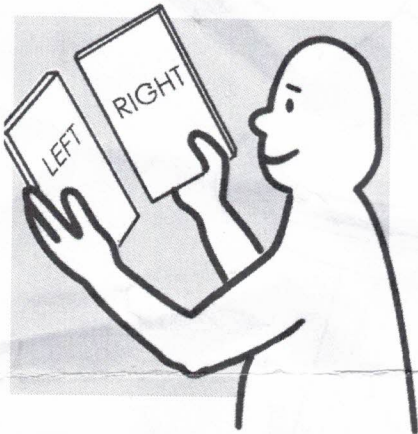

Carefully identify each component, especially those that are similar. The most common mistake is getting things back to front.

4



Separate and identify each component from the hardware pack and rest each one in its proper location before fastening.

5

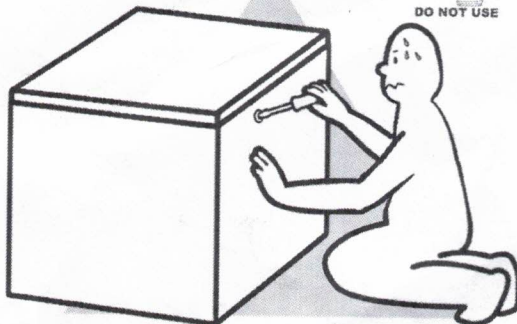

DO NOT fully tighten screws (leave slightly loose). When the item is fully assembled tighten the screws - but do not over tighten.

6

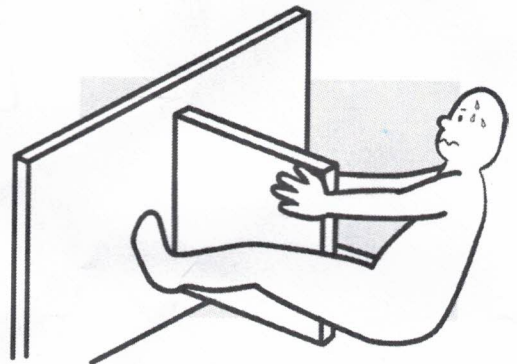

If glue is required **DO NOT** set until you are certain that the parts belong together.

What you Need



1 x Allen Key 4mm
(provided)



1 x Spanner KEY

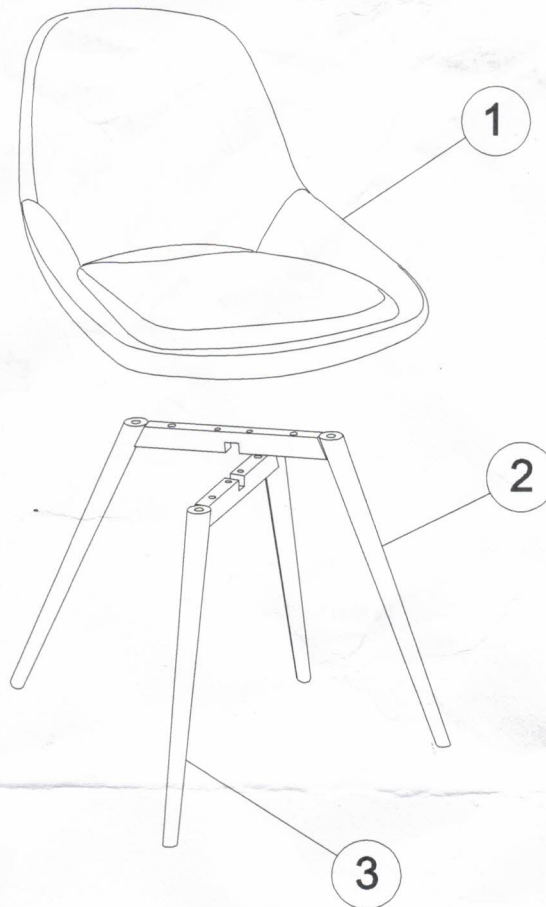

2*Brackets
A



4*Long Bolts
B



4*NUTS
C







12*Washers
D



4*Short Bolts
E

Please make sure you have all these parts before you start.

You Will Need



A	2*Brackets	
B	4*Long Bolts	
C	4*Nuts	
D	8*Washers	

1 x Allen Key 4mm
(provided)

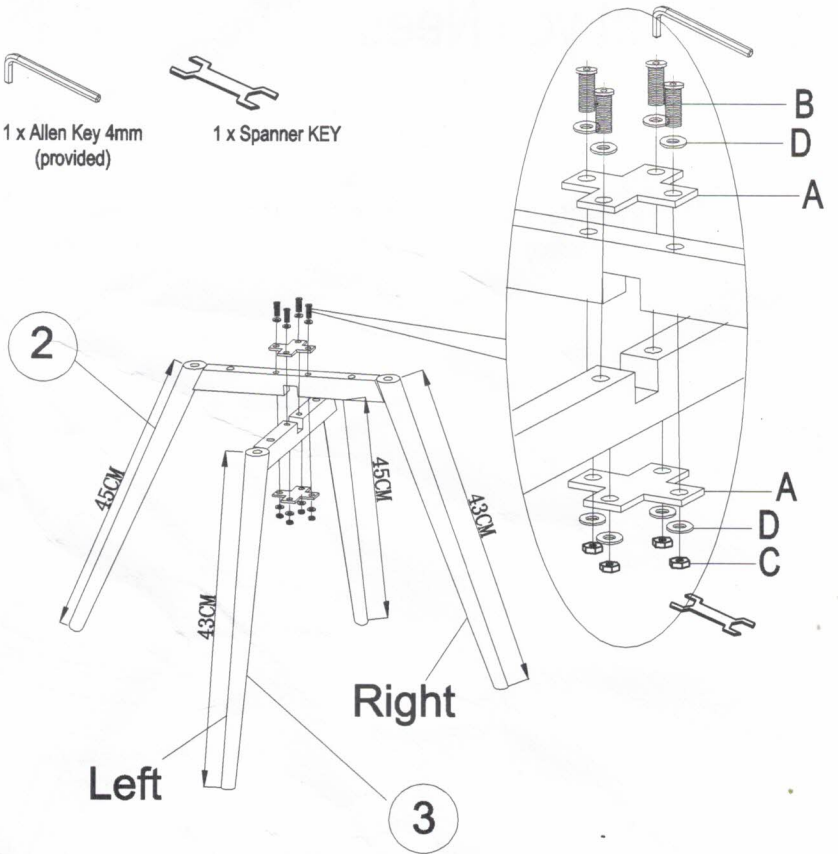

1 x Spanner KEY



You Will Need

E	4*Short Bolts	
D	4*Washers	

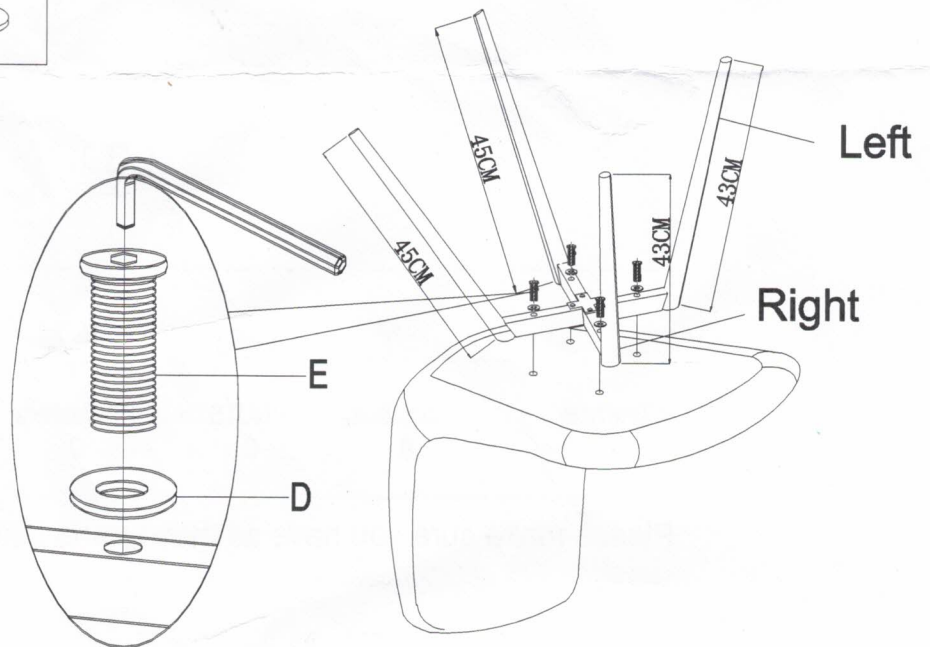
1 x Allen Key 4mm
(provided)



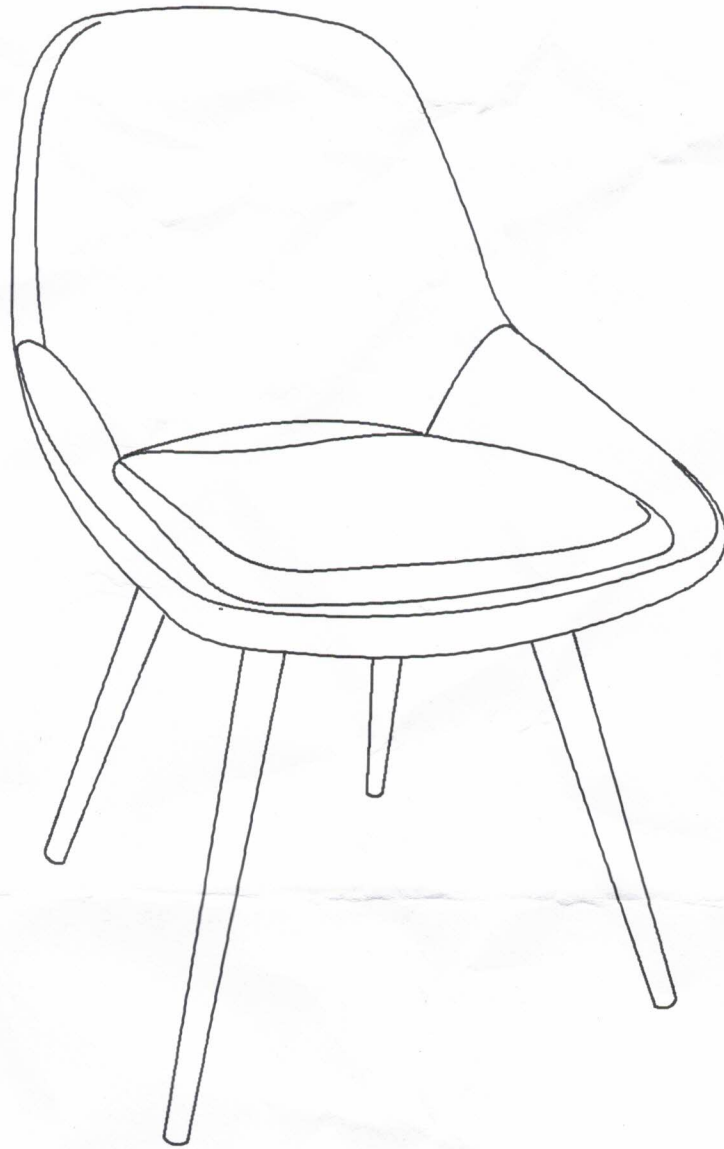

The job is now complete!

**In the interest of our environment
Please dispose of all packaging thoughtfully**