

# JK006-1I Assembly Instruction



a=4 M6x90



b=4  $\Phi$ 6



c=1 5mm

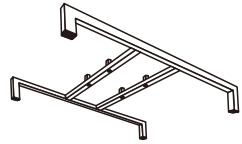
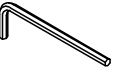

A=1

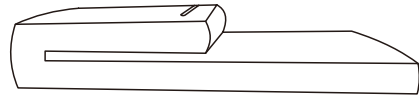

B=1

Unit=cm

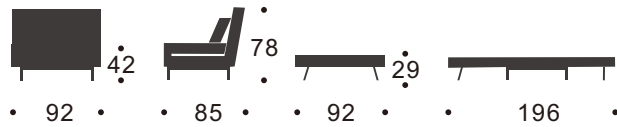

1

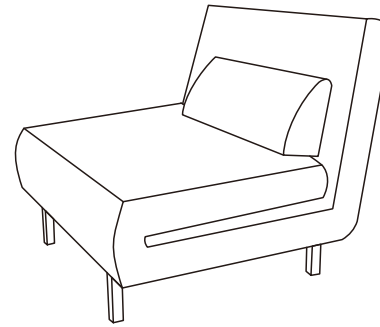

2

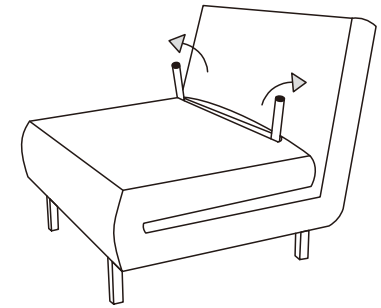

3

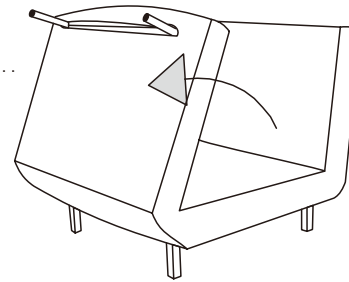

4

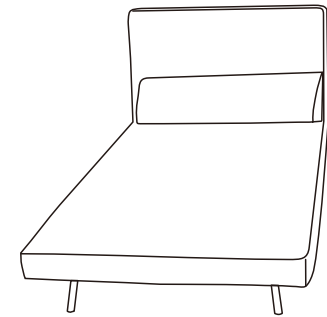

5

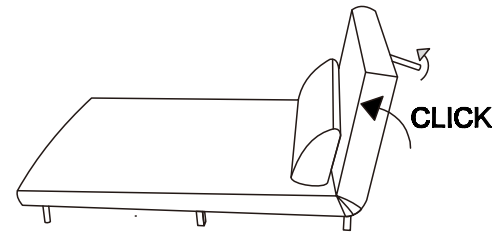

6

