

loungelovers

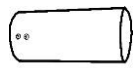

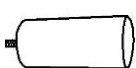

Assembly Instructions

Stella 4S Sofa

Components list

Picture	Name	Quantity
 (A)	Sofa Body	1
 (B)	Leg	4
 (C)	Center leg	1

Hardwares list

Picture	Name	Quantity
 (D)	Bolt (M8)	8
 (E)	Flat Washer	8
 (F)	Sprung Washer	8
 (G)	Allen key	1

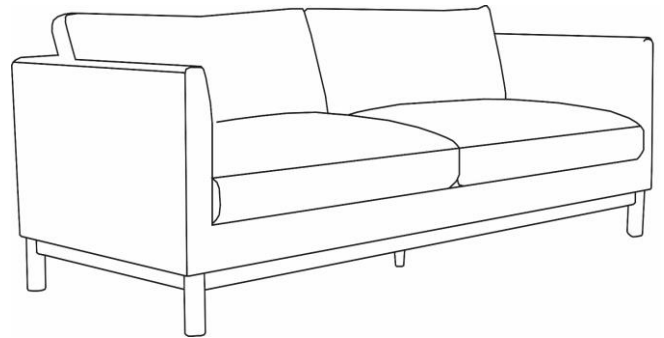

Sofa assembly steps:

PLEASE NOTE THE SOFA LEGS AND HARDWARE PACK IN THE POCKET UNDERNEATH SOFA!!

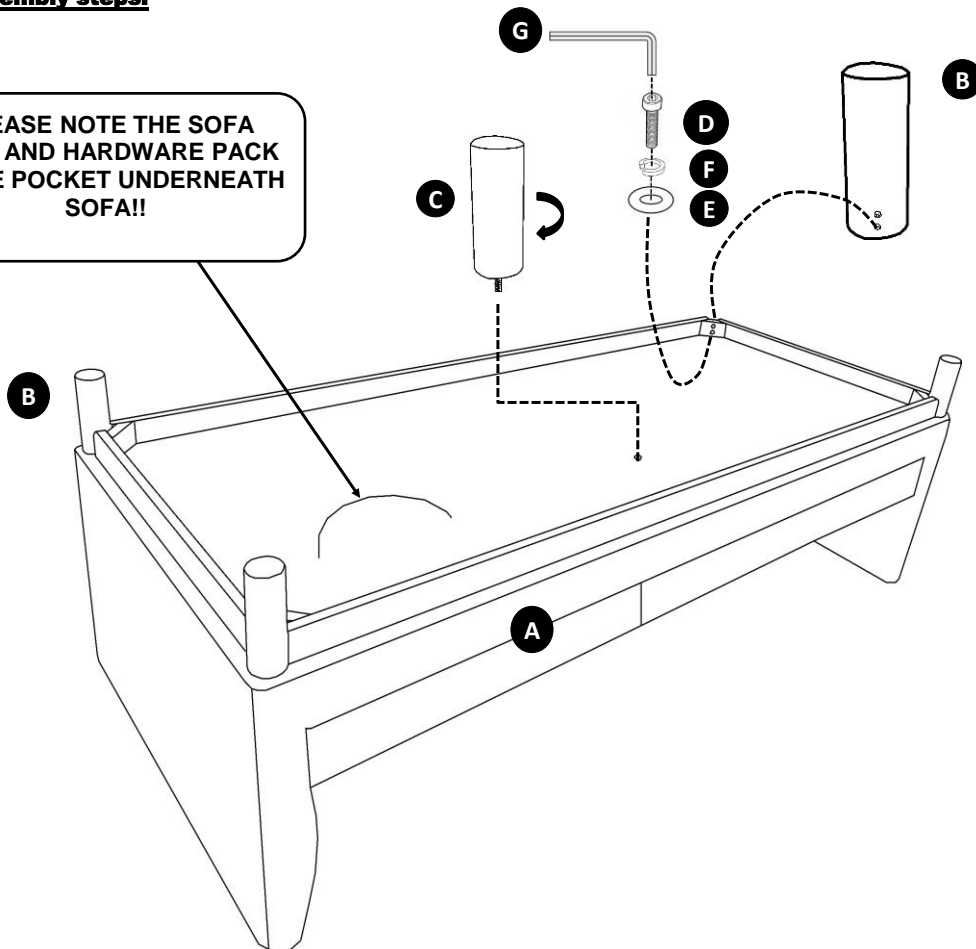

Please Note:

1. We suggest you spend a short time reading through this leaflet and then follow the simple step by step instructions.
2. Don't discard any of the packaging until you have checked that you have all the parts and the pack of fittings.
3. Assemble this item on a carpet.
4. We strongly advise that all the fittings are only finger tightened during initial assembly only, upon completion of the assembly should all fittings points be fully tightened.
5. We strongly recommend a period check on all fixing points to make sure they remain fully tightened.
6. Keep away from direct sunlight.

