

lounge lovers

Raja Sideboard

Thank you for purchasing the Raja Sideboard. Before you begin to assemble your new piece of furniture please check to ensure that all hardware and parts have been correctly supplied from the below parts description.

Please follow instructions closely as deviation from them may present a possible safety risk, damage the furniture and may void your warranty.

It is recommended that the assembly is done on a soft surface such as a carpet or blanket to avoid any damage the furniture or flooring.

If you experience any problems with your purchase, please contact Lounge Lovers customer care on 1300 738 088 or info@lounge lovers.com.au

WARNING: Ensure that the anti-tip strap or brackets are used to fix the furniture to the wall at the end of the assembly process.





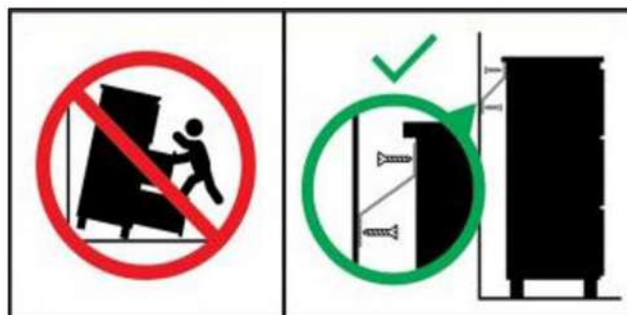

To prevent serious injury or death from furniture tipping over, it is critical that you securely attach the anti-tip straps or brackets provided to your wall using the appropriate wall fixings. Children have died from toppling furniture.

IMPORTANT:

- **DO NOT** place toys or other objects that might attract children on top of this furniture.
- **AVOID** opening more than one drawer at a time.
- **DO NOT ALLOW** children to climb on drawers, shelves, or any part of this furniture.
- **PROPER WEIGHT DISTRIBUTION:** Place heavier items in lower drawers or on lower shelves.



Hardware List

 1 - Ø4 x20 - 4 pcs	 2 - Ø4 x40 - 4 pcs	 3 - M8 x Ø13 - 4 pcs	 4 Anti Tip Kit -2 pcs	 20 MIN  	
---	---	---	--	---	--

1

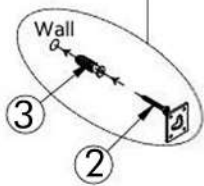
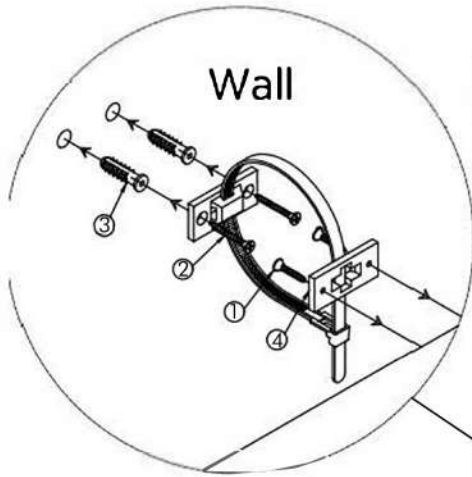

Note : Make sure plastic feet touch the ground after fixed bracket to the wall

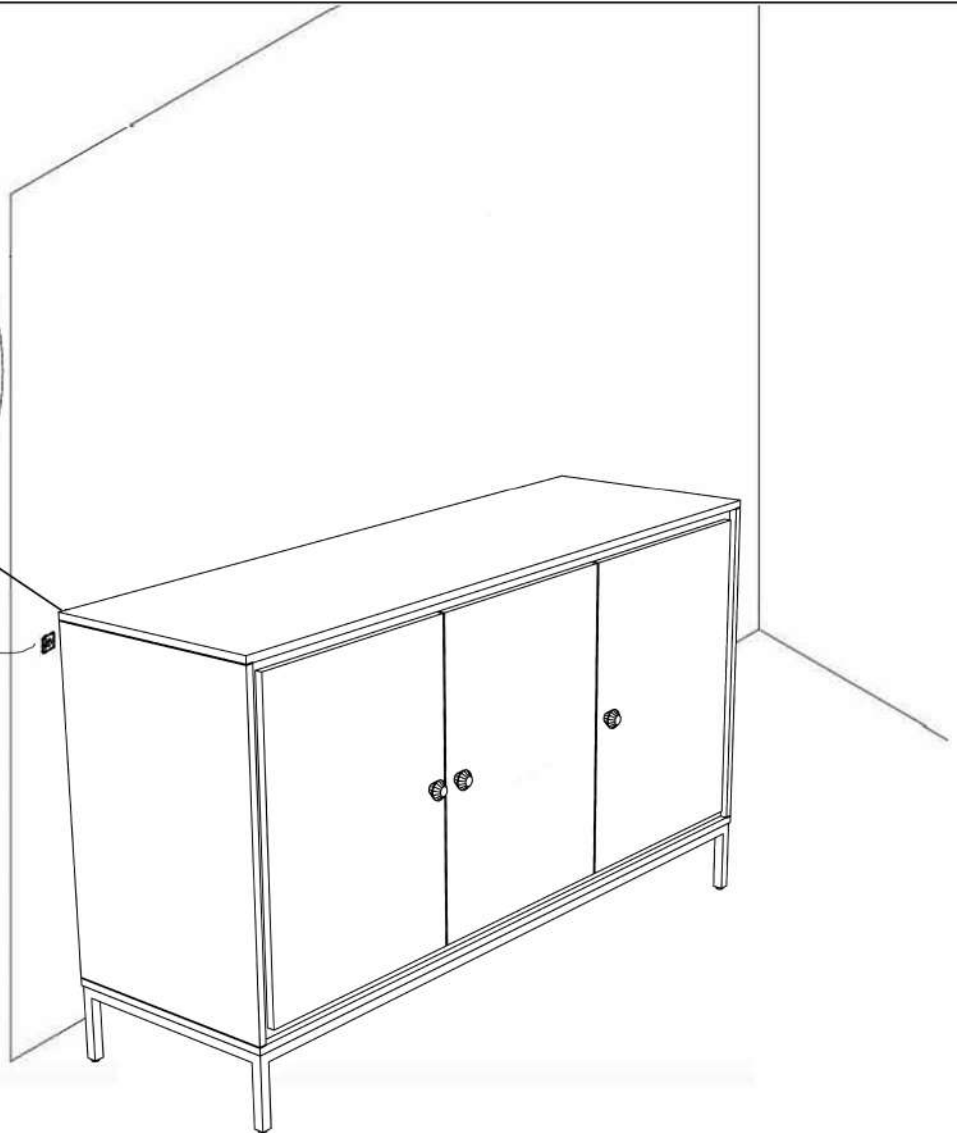

WARNING : Prevent Toppling Hazards

To ensure safety, secure your furniture to prevent tipping, which can cause serious injury or death. Follow these steps:

- **Use Anti-Tip Devices:** Always install the provided anti-tip restraints to anchor furniture to the wall.
- **Proper Weight Distribution:** Place heavier items in lower drawers or on lower shelves.
- **Prevent Climbing:** Supervise children and do not allow them to climb or hang on drawers, doors, or shelves.
- **Avoid Heavy Items on Top:** Do not place heavy items on top of furniture, including TV's unless the item is designed for such use.
- **Test Stability:** After assembly, check stability by gently pulling on drawers, doors, or shelves.
- **Regular Checks:** Periodically inspect anchoring devices and furniture stability.

Stay Safe: Anchor Your Furniture Properly



CAUTION: When attaching the anti-tip fixings:

- **CHECK** for electrical wires or plumbing inside the wall before drilling any holes. If you are unsure, seek professional advice.
- **UNDERSTAND** that walls are made from different materials (e.g. solid brick, hollow plasterboard), and it's important to use the correct wall fixings for your wall type.

Your local hardware store can provide the necessary drills and fixings and offer advice if needed or seek professional advice from a tradesman.

AFTER ASSEMBLY:

PERFORM A STABILITY TEST to ensure the furniture is stable and securely anchored. Gently push the furniture to confirm it does not wobble or tip over.

PERIODIC CHECKS:

REGULARLY INSPECT the furniture to ensure that the anti-tip straps or brackets remain securely attached to both the furniture and the wall. Tighten any loose fixings immediately.