

loungelovers

BONDI ROUND DINING TABLE

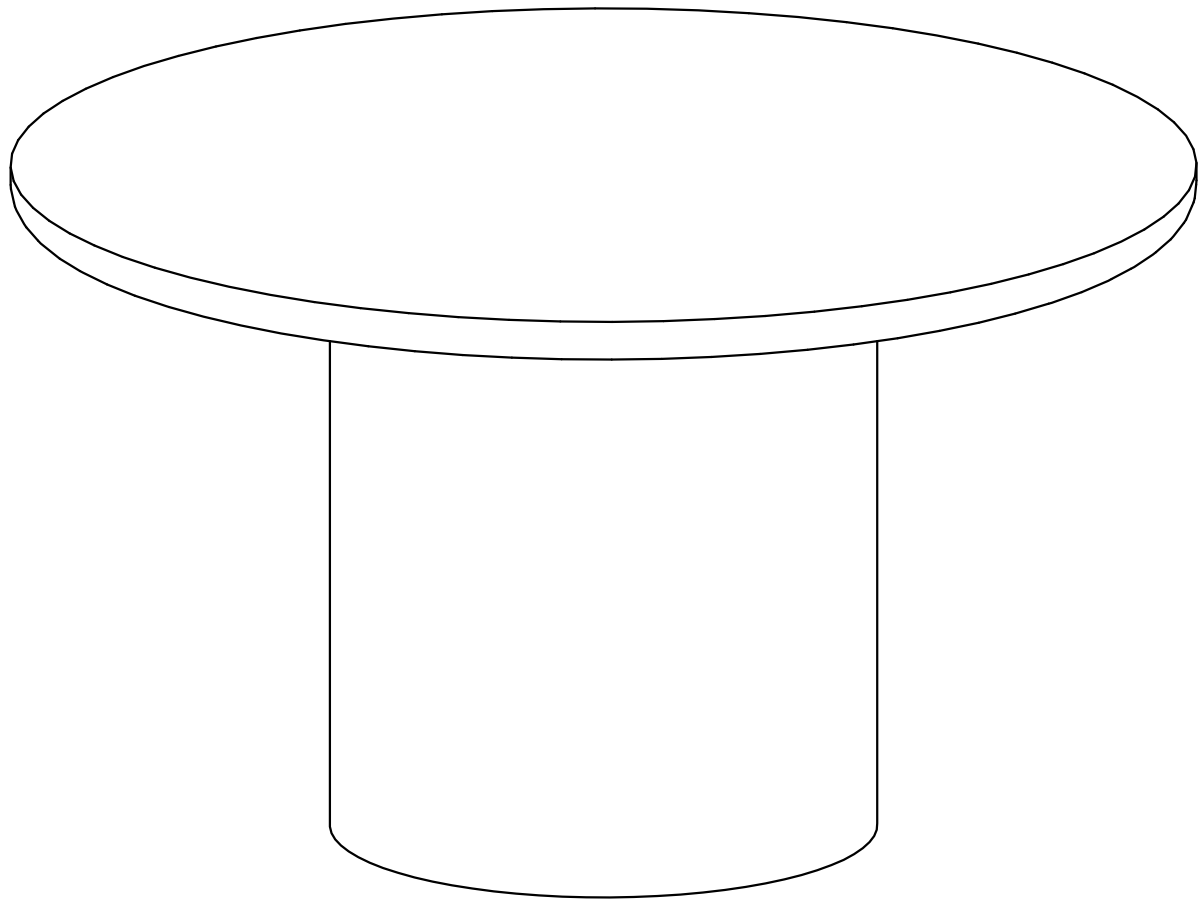

D130xH76cm



x 2

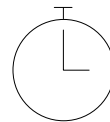



20'

loungelovers

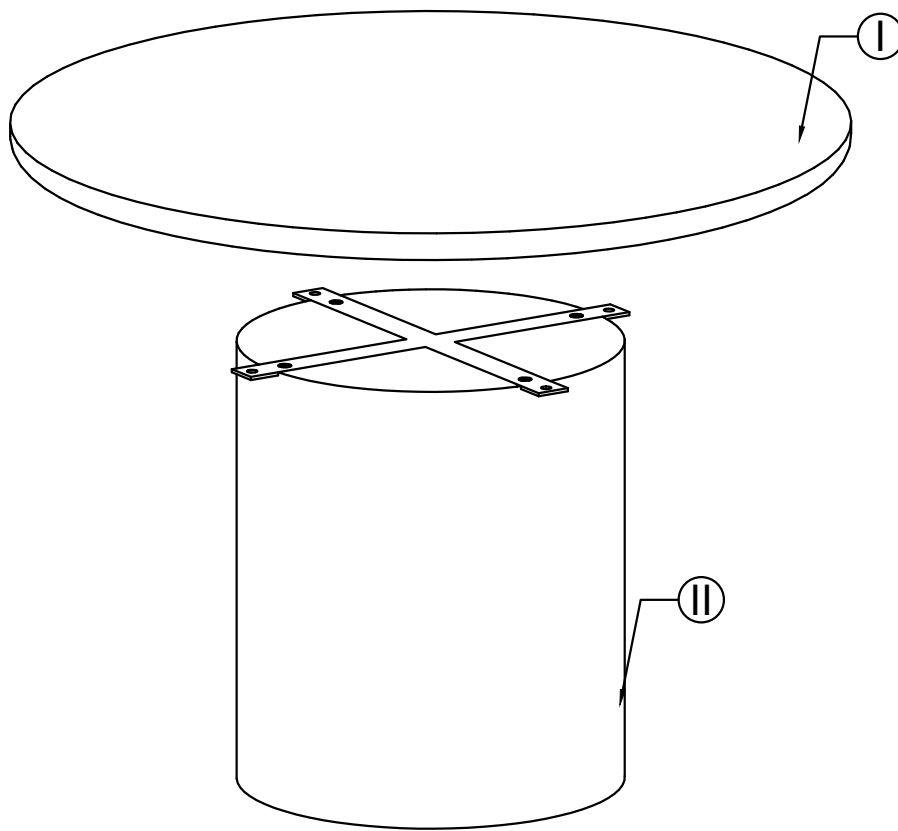
BONDI ROUND DINING TABLE

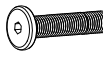

- | | | | |
|-----|-------------------|---|----|
| (A) | Bolt M8x40 |  | x4 |
| (B) | Flat washer M8x22 |  | x4 |
| (C) | Allen Key M4x60 |  | x1 |

loungelovers

BONDI ROUND DINING TABLE

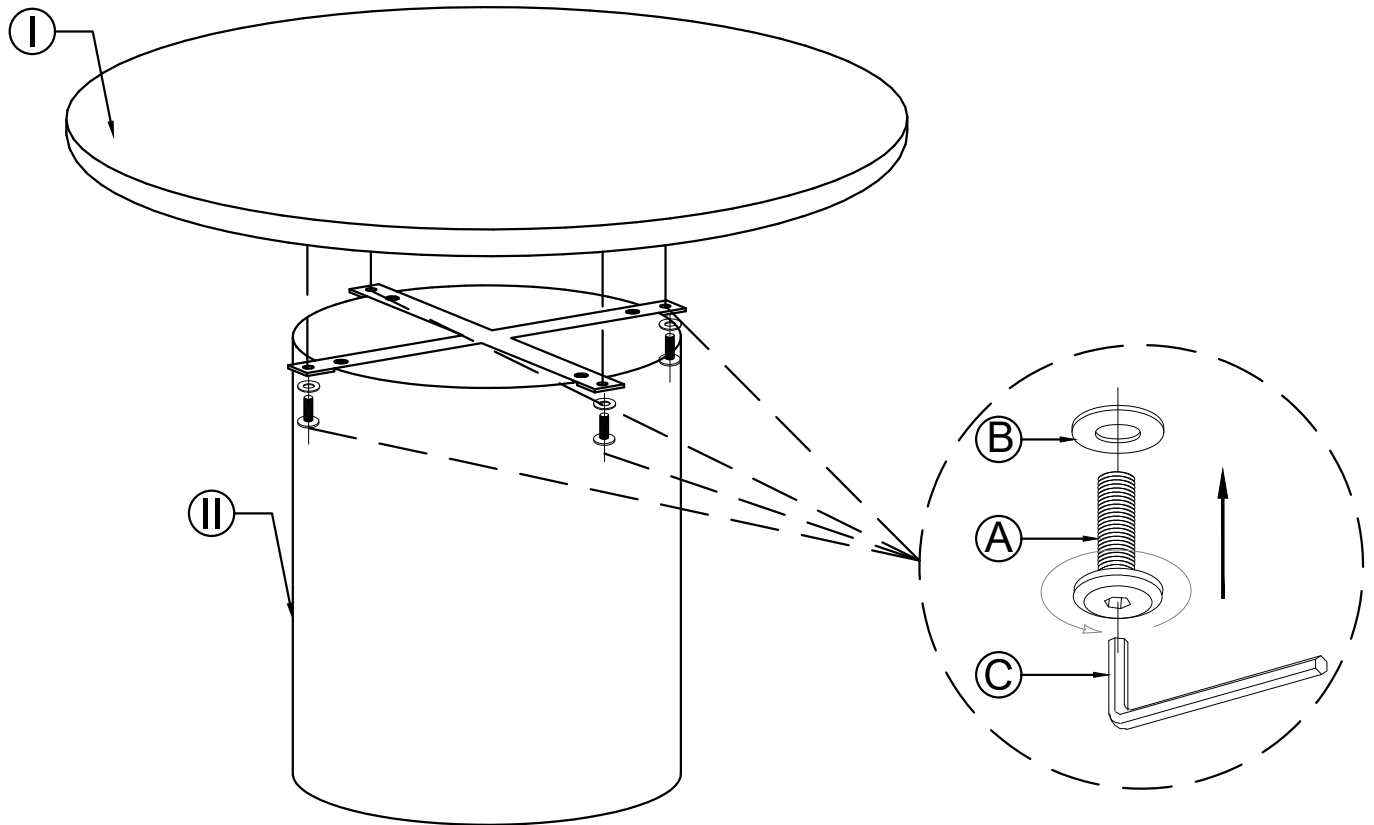

Step 1 : Turn half way 50% => Loosely install the 4 bolts to ensure the bolt holes line up.

Step 2 : Tightening 100% => Tighten the bolts to fully secure the table top to base

